

Инструкция по сборке Instructions for assembling furniture Instrukcja montażu mebli

Набор мебели для Collection Kolekcja mebli
общей комнаты «MONAKO»

Шкаф с витриной 1V2D1S
Cabinet-showcase 1V2D1S
Szafa-witryna 1V2D1S

AH-028.35.00.00

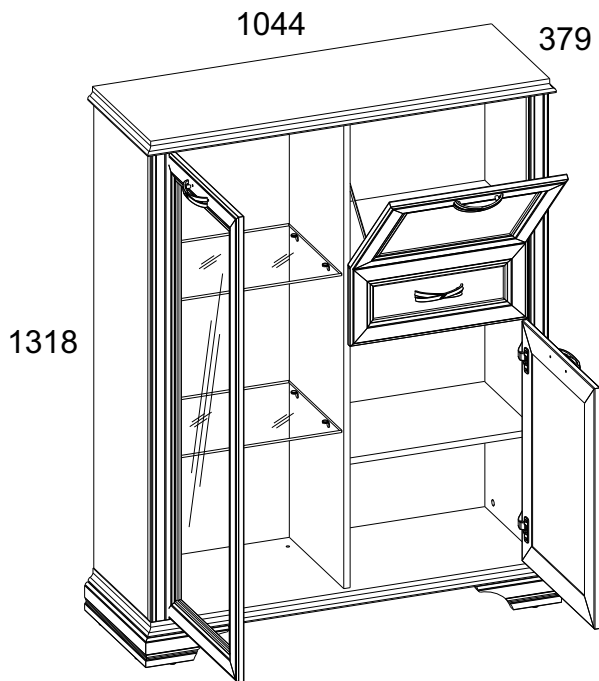

Дата изготовления
Production date
Data produkcji

Штамп ОТК
Stamp of Quality Department
Pieczęć Działu Jakości

ИООО « АНРЭКС »
Республика Беларусь, 224004
г.Брест, ул. Катин Бор, 119
тел/факс (+375 162) 30-17-07



EAЭС №BY/112 11.01. TP025 018.01 01538
от 29.12.2022
по 28.12.2027

Инструкция по эксплуатации.

Качество и комплектность изделия рекомендуется проверять в магазине при покупке в распакованном виде. Сборка изделия должна производиться в порядке, изложенном в настоящей инструкции. В процессе эксплуатации изделий необходимо периодически затягивать ослабленные винтовые соединения. В случае необходимости перемещения изделия по квартире перед его перестановкой, необходимо полностью освободить его от груза (матраца). Во избежание поломок имеющих опор передвигание производить приподнимая изделие над уровнем пола. Запрещён прямой контакт с водой. Удаление пыли с изделий следует производить слегка влажной мягкой салфеткой. Во избежание коробления деталей и изменения цвета изделия следует избегать установки мебели на прямых солнечных лучах.

При эксплуатации изделий набора **ЗАПРЕЩАЕТСЯ:**

- устанавливать мебель вблизи отопительных приборов и вплотную к сырým стенам и в помещениях с относительной влажностью более 70%;
- температура нагрева элементов мебели не должна превышать +40 °С.
- в процессе сборки и эксплуатации изделий набора становиться ногами на горизонтальные щиты и витрины;
- применять химические чистящие средства для уборки мебели;

Гарантии изготовителя.

1. Гарантийный срок эксплуатации изделия - 24 месяца со дня продажи магазином. В период гарантийного срока изготовитель гарантирует ремонт изделий или их замену, если потребителем не нарушены правила эксплуатации.
2. Претензии предъявляются потребителем непосредственно в торгующую организацию, в которой была приобретена мебель, предъявив настоящую "Инструкцию по сборке" и копию товарного чека.
3. Изделие **Шкаф с витриной 1V2D1S**, входящее в состав набора мебели для общей комнаты **«МОНАКО»**, соответствует требованиям ГОСТ 16371-2014, ТР ТС 025/2012.
4. Срок службы мебели - 5 лет.
5. Предприятие-изготовитель оставляет за собой право вносить изменения в конструкцию изделия, не ухудшая его конструктивные и эксплуатационные характеристики.
6. Для сборки изделий рекомендуется привлекать квалифицированных специалистов.

Запах.

От новой мебели может исходить запах материалов, из которых она изготовлена. Запах может сохраняться в течение трёх недель с момента сборки. Для снижения интенсивности запаха рекомендуется:

- для мягкой мебели - пропылесосить изделие и проветрить помещение.

Повторять 3-4 раза в день.

- для корпусной мебели – протирать тканью, смоченной мягким моющим средством, вытирать чистой сухой тканью и проветривать помещение, предварительно открывая все двери и ящики изделия.

Повторять 3-4 раза в день.

Важно! Сохраните, пожалуйста, инструкцию в случае повторной сборки мебели или рекламации. В случае составления рекламации пользуйтесь, пожалуйста, обозначением из инструкции сборки.

PL

Przy eksploatacji mebli zabrania się:

- ustawiać meble w pobliżu grzewczych przyrządów i obok wilgotnych ścian, a także w pomieszczeniach ze względną wilgotnością więcej niż 70%;
- temperatura nagrzewania elementów mebli nie może przekraczać +40°C;
- w trakcie montażu i eksploatacji mebli stawać nogami na poziome panele i witryny;
- stosować chemiczne środki czyszczące do sprzątania mebli;
- nie należy narażać na kontakt z wodą.

Gwarancje producenta.

1. Gwarancyjny termin eksploatacji wyrobu - 24 miesiące z dnia sprzedaży. W okresie gwarancyjnego terminu producent gwarantuje naprawę wyrobów lub ich zamianę, jeżeli reguły eksploatacji nie zostały naruszone przez nabywcę.
2. Roszczenia są przekazywane przez nabywcę bezpośrednio do handlującej organizacji, w której były nabyte meble, tylko przy okazaniu danej "Instrukcji montażu" wraz z dokumentem zakupu.
3. Wyrób **Szafa-witryna 1V2D1S**, wchodzące w zestaw mebli „**MONAKO**”, odpowiada wymaganiom Norm Państwowych 16371-2014, TP TC 025/2012
4. Trwałość użytkowa mebli - 5 lat.
5. Firma-producent pozostawia za sobą prawo do wprowadzania zmian w konstrukcje wyrobów, nie pogarszając ich konstruktywne i eksploatacyjne charakterystyki.
6. Do montażu wyrobów zaleca się skorzystanie z pomocy wykwalifikowanych specjalistów.

Zapach.

Nowe meble mogą wydzielać zapach materiałów, z których są wykonane. Zapach może utrzymywać się do trzech tygodni od momentu montażu. Aby zmniejszyć intensywność zapachu, zaleca się:

- w przypadku mebli tapicerowanych - odkurzyć produkt i przewietrzyć pomieszczenie. Powtarzaj 3-4 razy dziennie.
- dla mebli szafkowych - przetrzyj ściereczką zwilżoną łagodnym detergentem, przetrzyj czystą, suchą ściereczką i przewietrz pomieszczenie, uprzednio otwierając wszystkie drzwi i szuflady produktu. Powtarzaj 3-4 razy dziennie.

Ważne! Proszę zachować instrukcję w razie ponownego montażu mebli lub reklamacji. Podczas składania reklamacji prosimy o korzystanie z oznaczeń z instrukcji.

EN

Instruction manual.

It's advised to check the quality and completeness of the product in the store when buying unpacked. Assembling of the product should be done the way it's described in this manual. While the product is in service loose screw connections should be periodically tightened. If it's necessary to move items around the apartment before moving you should release the product completely from the load (the mattress). To prevent damage to existing supports the product should be lifted before moving. Furniture should not be exposed to contact with water. Dusting the product should be done with a slightly damp soft cloth. To prevent warping of parts and discoloration of products do not install furniture in direct sunlight.

While the product is in service it's PROHIBITED TO:

- Install furniture near heating devices, close to the raw walls and in rooms with a relative humidity of more than 70%;
- heat elements of furniture to the temperature higher +40°C;
- step on the horizontal shields and windows during assembly and use of the products set;
- use chemical cleaners for cleaning furniture;

Manufacturer's warranty.

1. The warranty period of use of the product - 24 months from the date of sale. During the warranty period the manufacturer guarantees repair or replacement of products, if the user has not violated operating rules.
2. Claims should be made by the consumer directly to the trading organization, in which furniture was purchased, presenting the "Instruction manual" and a copy of the sales receipt.
3. The product **Cabinet-showcase 1V2D1S**, which is part of a set of "**MONAKO**", meet the requirements of GOST 16371-2014, TR TS 025/2012.
4. The lifetime of furniture - 5 years.
5. The manufacturer reserves the right to make changes in product design, without compromising its design and application requirements.
6. To assemble the products it's recommended to attract qualified personnel.

Smell.

New furniture may emit the smell of the materials from which it is made. The smell can persist for up to three weeks from the time of assembly. To reduce odor intensity, it is recommended:







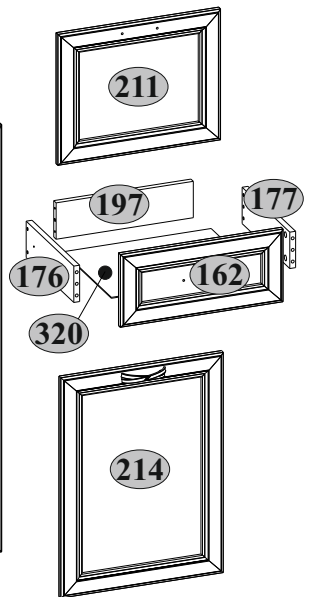
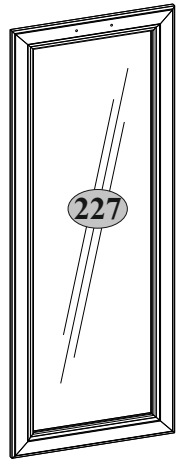
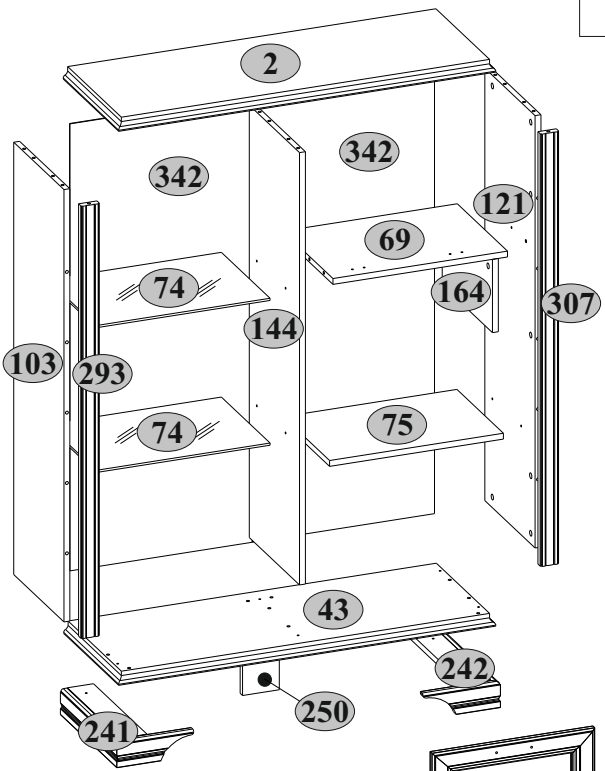
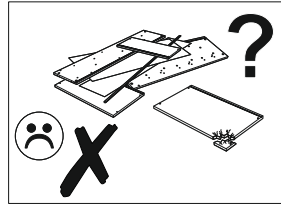

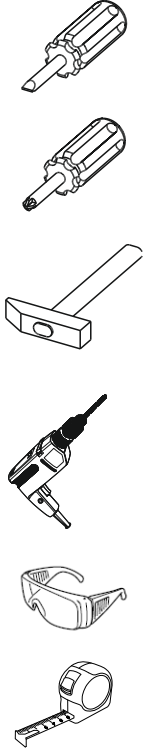



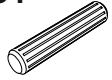
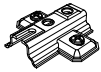
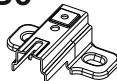









- for upholstered furniture - vacuum the product and ventilate the room. Repeat 3-4 times a day.
- for cabinet furniture - wipe with a cloth dampened in a mild detergent, wipe with a clean, dry cloth and ventilate the room, previously opening all doors and drawers of the product. Repeat 3-4 times a day.

It is important! Keep the instruction in case of reassembly of furniture or complaint. When making a claim use the notation from the instruction.

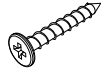
№ п/п	Длина мм.	Ширина мм.	Толщина мм.	Кол-во шт.	№ пачки
2	1026	370	32	1	1/5
43	1026	367	32	1	1/5
69	475	335	16	1	3/5
74	473	325	6	2	3/5
75	473	310	16	1	3/5
103	1180	335	16	1	3/5
121	1180	335	16	1	3/5
144	1180	335	16	1	3/5
162	446	200	19	1	4/5
164	335	200	16	1	1/5
176	320	100	16	1	1/5
177	320	100	16	1	1/5
197	376	100	16	1	1/5
211	360	446	19	1	4/5
214	606	446	19	1	4/5
227	1174	446	19	1	4/5
241	376	210	70	1	2/5
242	376	210	70	1	2/5
250	100	86	16	1	1/5
293	1180	50	19	1	3/5
307	1180	50	19	1	3/5
320	406	325	2,5	1	4/5
342	1220	496	2,5	2	5/5



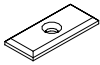

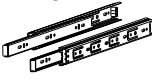

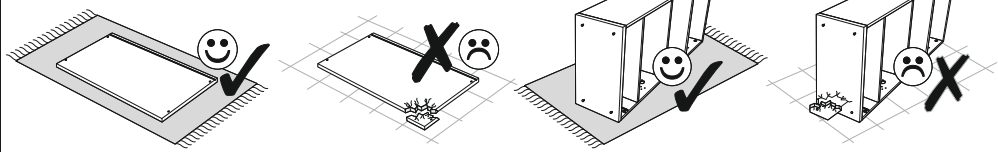
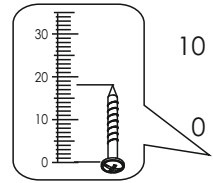
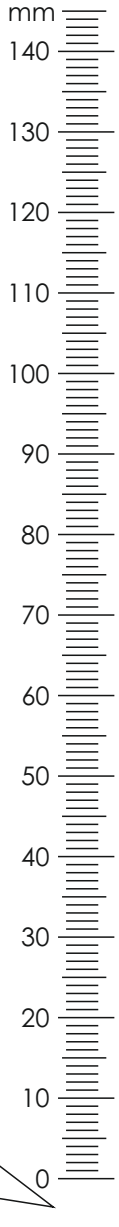
A1.0  5x28 26	A2  Ø15x13 26	C1  8x35 28	D1  2
D3  4	E2-1  4	E4  2	G  1,5x26 32
H22  4	I  S4 1	J12  1	M1  M4x12 2
M12  M4x25 6	N1  7	P4  12	Q  1,5x7 6
R2  3x16 3	R3  3x20 13	R10  4x30 4	R23  6,3x13 12
R24  7x50 6	R27  5,0x13 10	R102  3,5x16 15	S3  5
S5  Ø18 22	S9  Ø12 2	Z10  300 1	



1

A1.0

 5x28

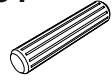
A2

 1 Ø15x13

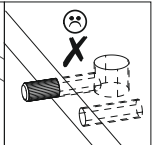
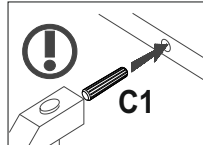
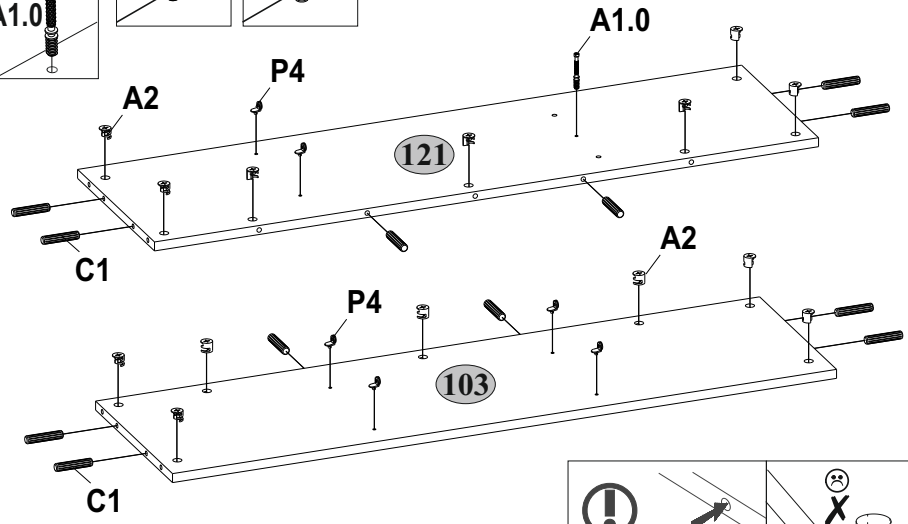
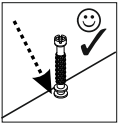
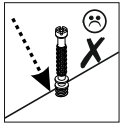
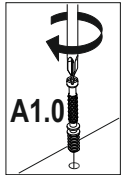
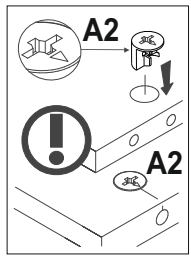
C1

 14 8x35

P4

 12 6



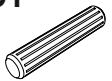

2

A1.0

 5x28

A2

 2 Ø15x13

C1

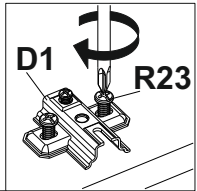
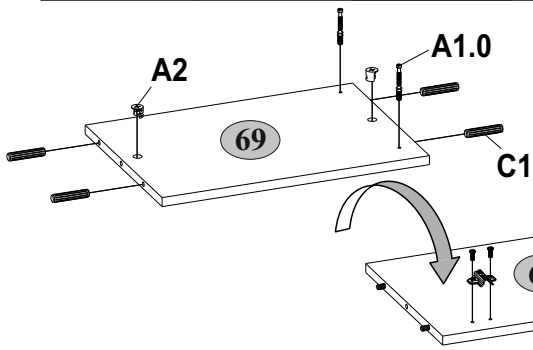
 2 8x35

D1

 4

R23

 2 6,3x13



3

A1.0



5x28

A2



1

Ø15x13

C1

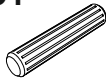

8x35

P4



4

6

R27



5,0x13

Z10

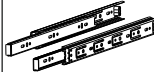

6

300

1

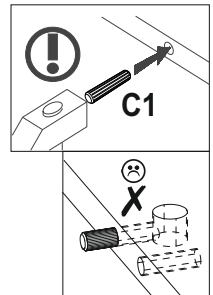
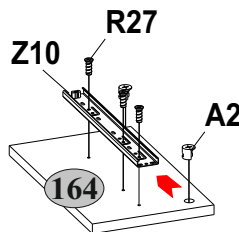
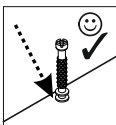
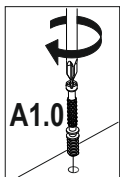
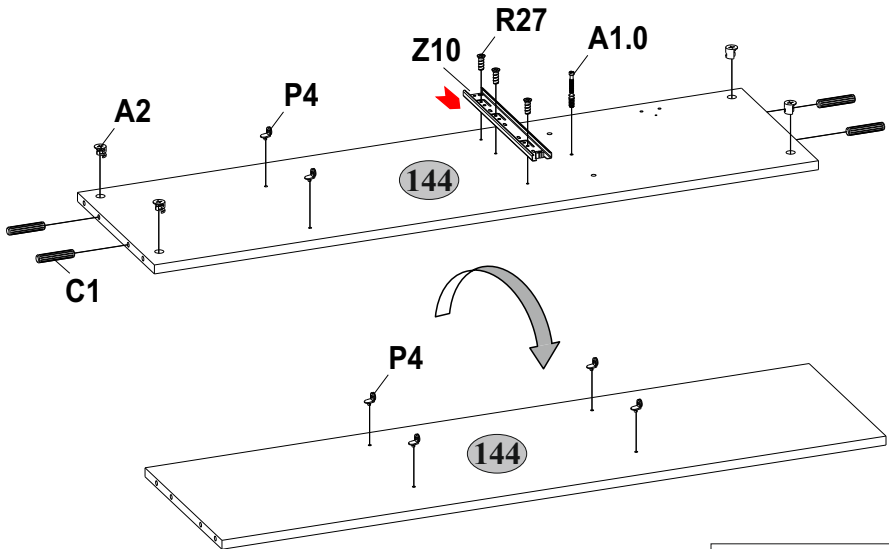
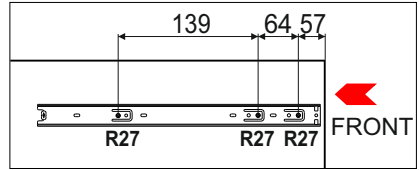
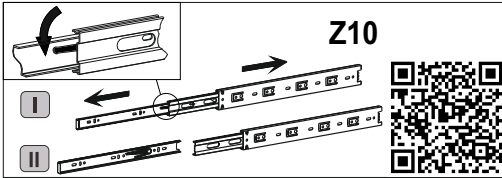
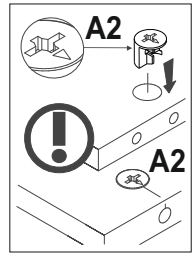

4

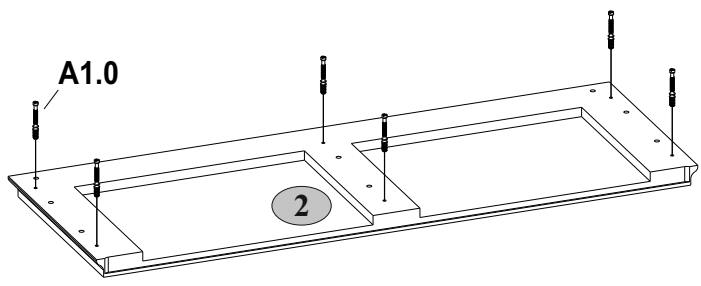
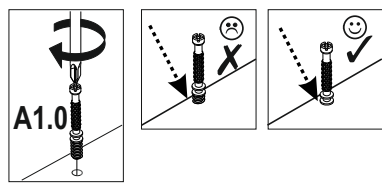
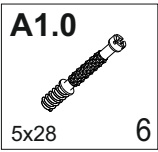

5

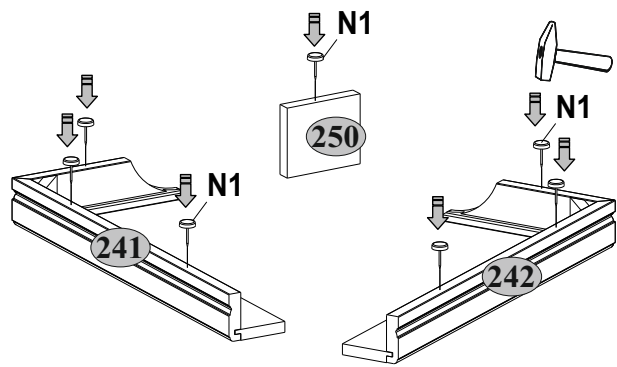
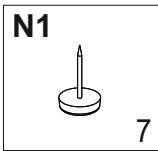

6**A1.0**

5x28

I

6 S4

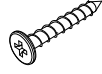
R10

1 4x30

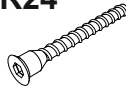
R24

4 7x50

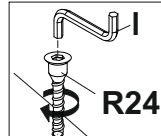
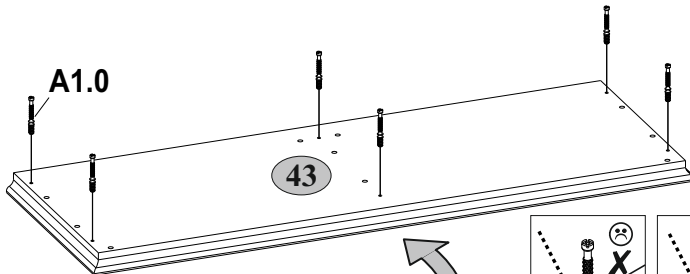
**I**

90°

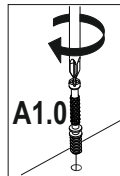
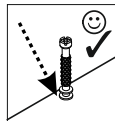
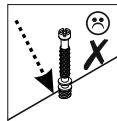
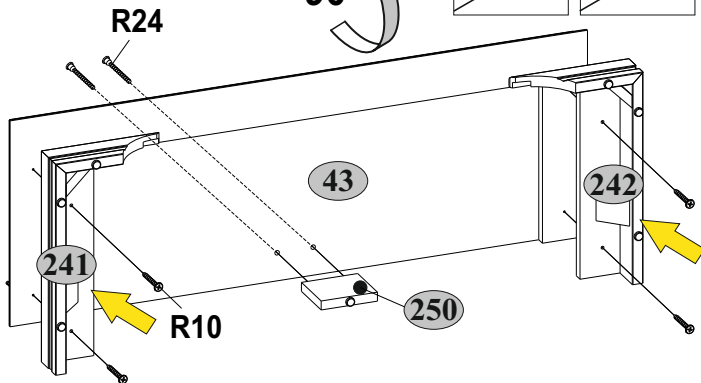
**II****7****A1.0**

5x28

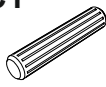
C1

6 8x35

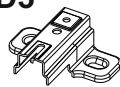
D3

4

R23

4 6,3x13

8

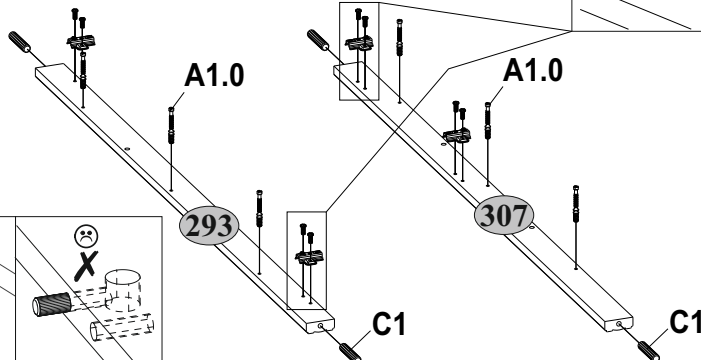
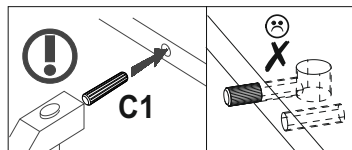
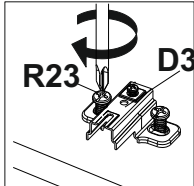

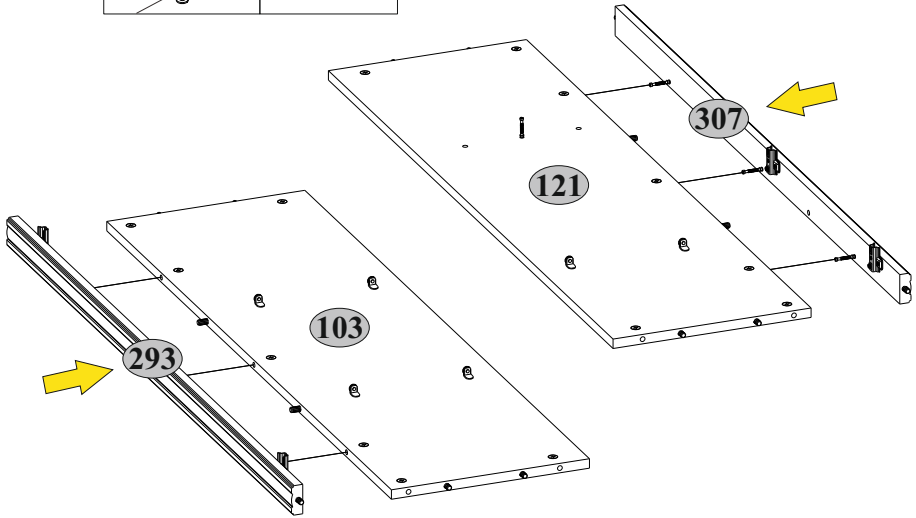
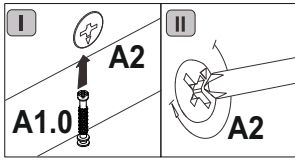
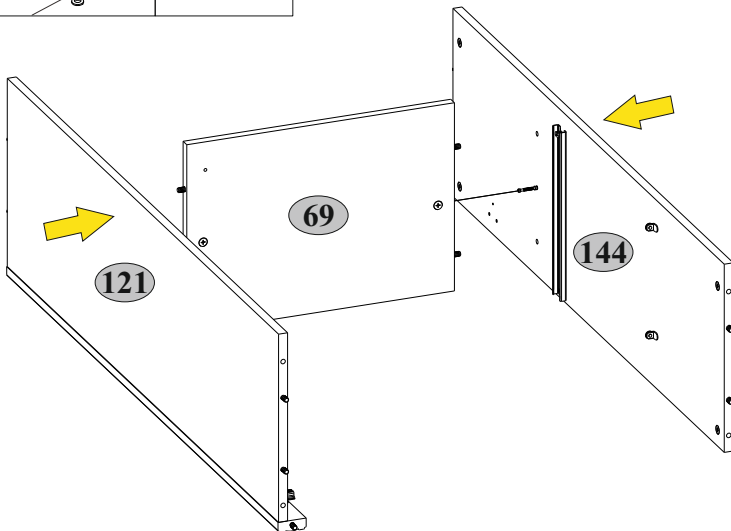
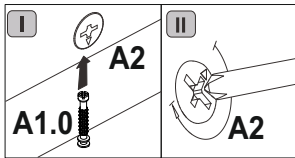
8**9**

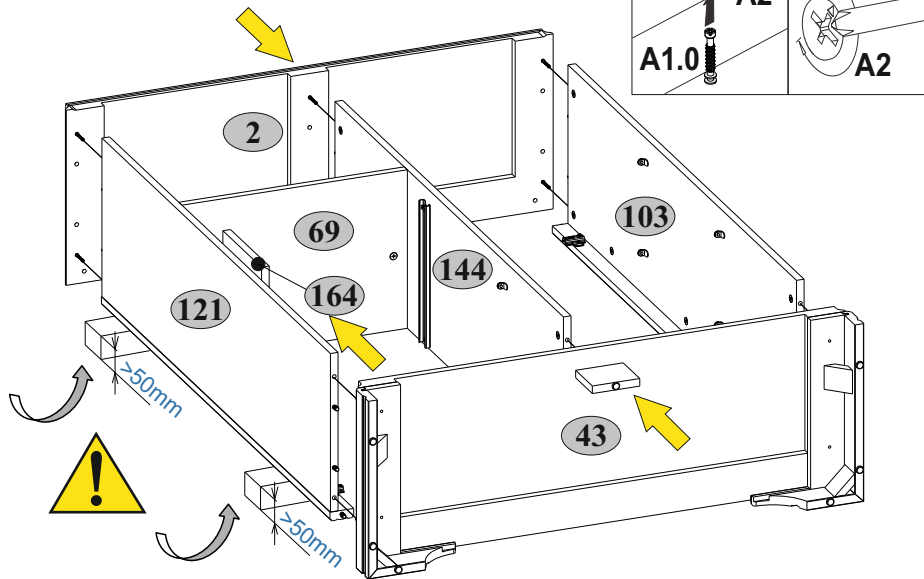
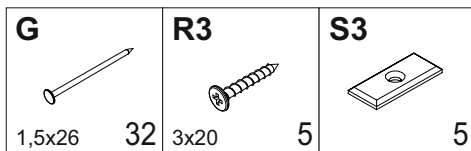
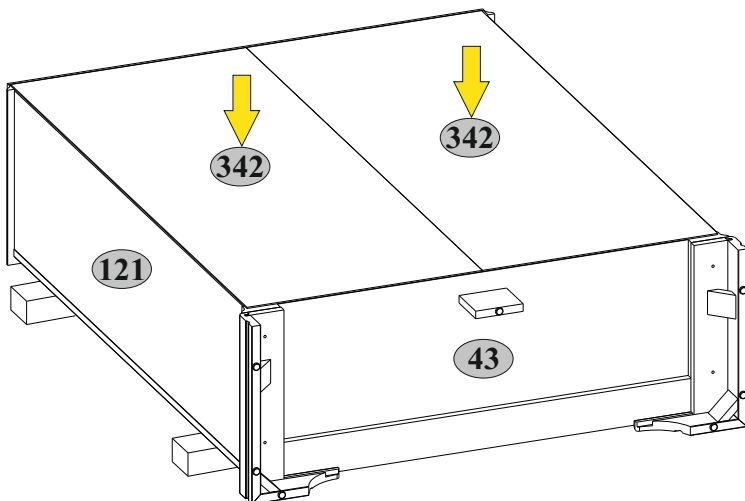
10**11****I**

II

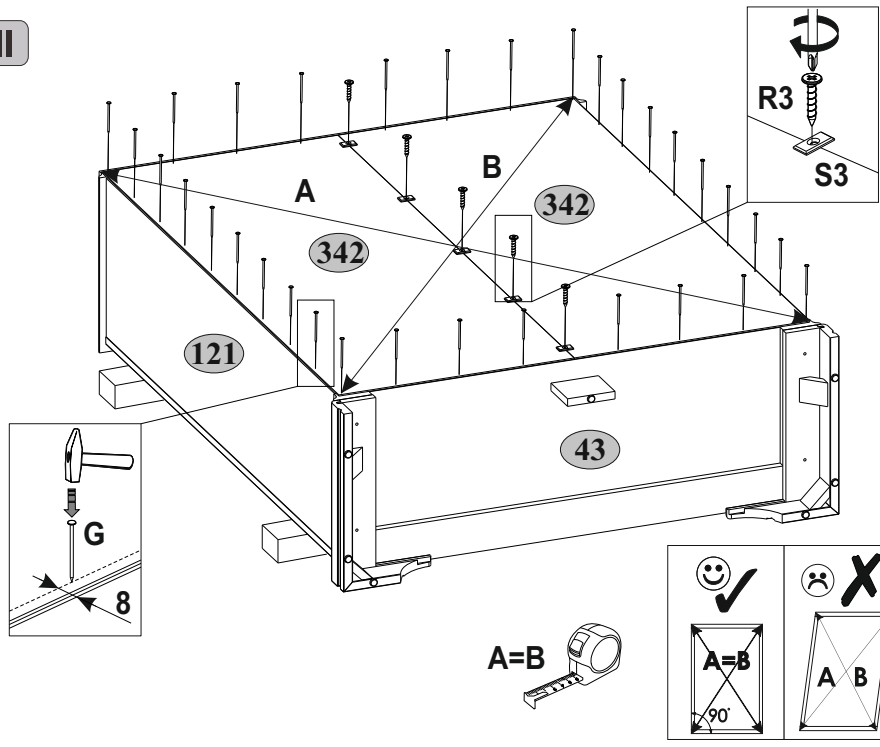

12

- | | | | |
|--------------------|---------------------|---------------------------|-----------------------------|
| E4

2 | H22



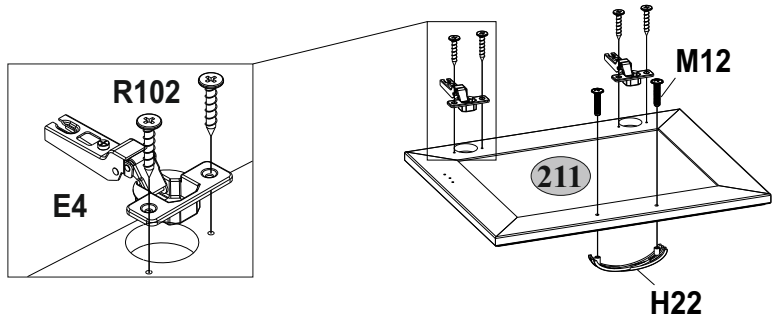

1 | M12

M4x25 2 | R102

3,5x16 4 |
|--------------------|---------------------|---------------------------|-----------------------------|

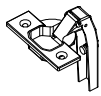





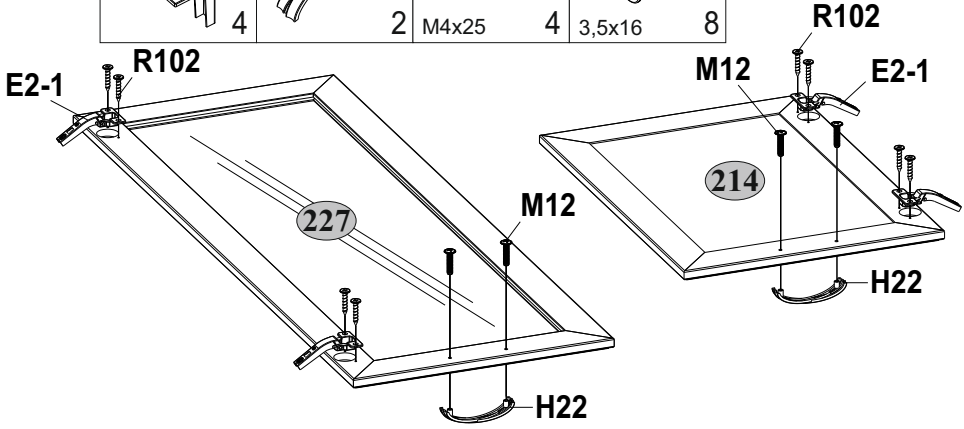



13

E2-1  4	H22  2	M12  4	R102  8
---	--	--	---

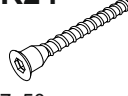

14

A1.0  5x28 4	A2  Ø15x13 4	C1  8x35 4	H22  1
I  S4 1	M1  M4x12 2	R24  7x50 4	R27  5,0x13 4

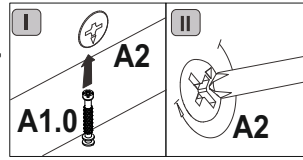
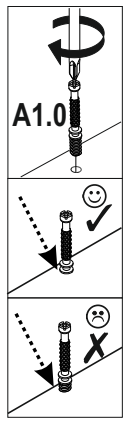
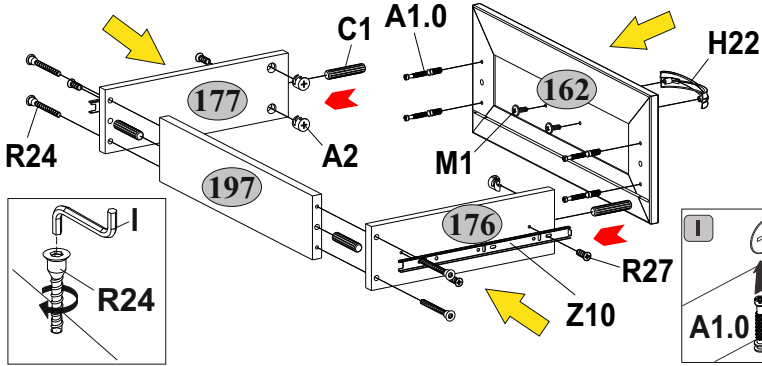
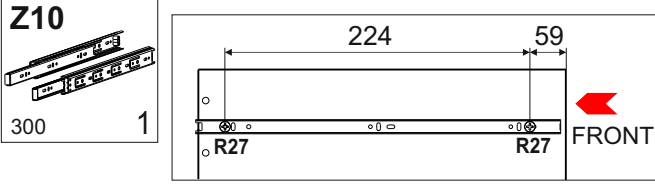
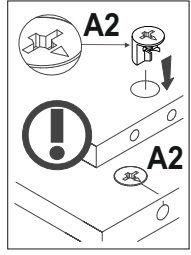

15**R3**

3x20

8

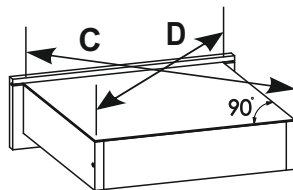
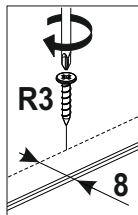
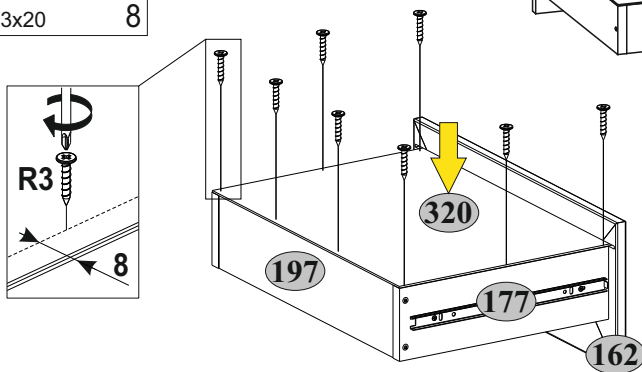
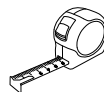
**C=D****16****Q**

1,5x7

S5

6

Ø18

S9



22

Ø12

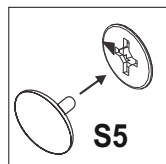
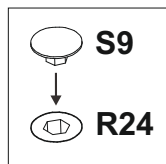
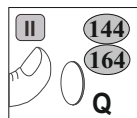
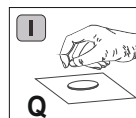
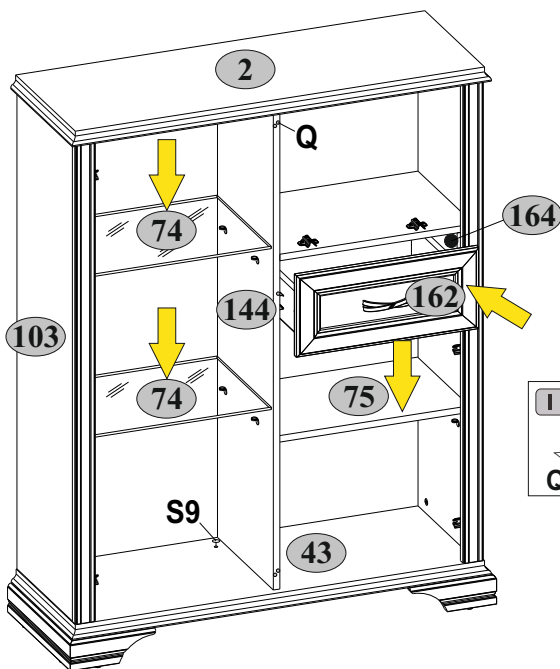

2

**S5****S9****R24**

17

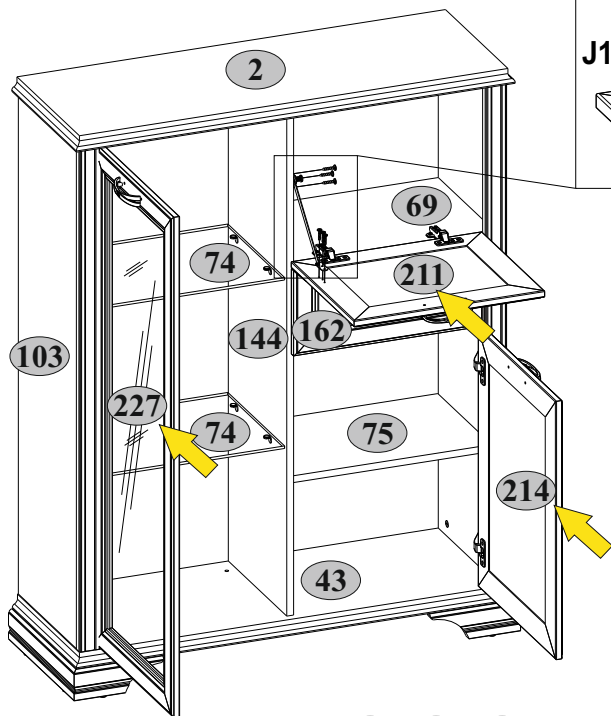
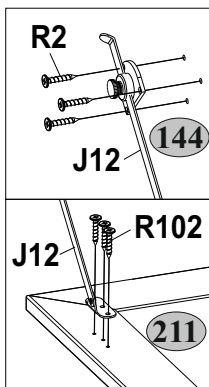
J12	R2	R102
		
1	3x16	3 3,5x16 3



69	74	75	162	 max. 5 kg
2	43			 max. 20 kg

